



NEW CAMO



HUNT ANYWHERE.
HUNT ORION.

www.huntorion.com

MODULAR • LIGHTWEIGHT • INSULATED • AMERICAN STEEL

BLIND PURSUIT

HUNT WITHOUT LIMITS.

Orion's modular, lightweight, all aluminum design allows you to set up camp anywhere you want to hunt - no heavy equipment, no problem.



WATCH THE SETUP
IN ACTION

MODULAR
**15 MINUTE
SETUP**
PATENTED

1



2



3



4



5



6



BLIND PURSUIT

SCAN ME
TO VIEW
ONLINE



\$

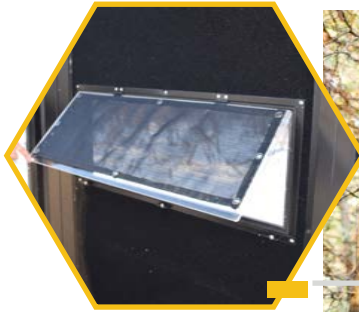

HINGED WINDOWS

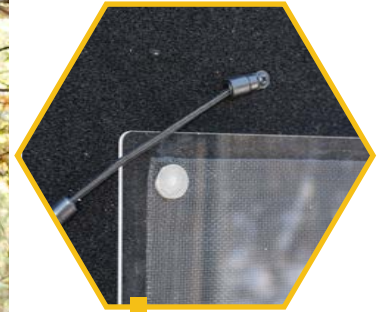

BUNGEE
WINDOW HOLD



PROPANE
HOSE PORT



VERTICAL OR
HORIZONTAL
TRANSPORTATION

ENGINEERED FOR STEALTH AND STABILITY

Modular Assembly

No tools required with our Patented quick-latch system.

No Heavy Lifting - Lightweight

Panels weigh between 15-35 lbs.
Total blind weighs 250 lbs.

Warm and Quiet - Insulated

2" foam insulation.
Blackout carpet on floor and walls.
R11 insulated panels.

Snow Problem

Black roof design melts snow.
Panel construction designed to handle the most extreme snow loads. 100 lbs./ft²

No Sweat Roof

Insulation and venting allow heating without dripping and condensation.

Packaged Flat

Modular design allows it to fit in the bed of all standard size pickup trucks, with our stand up or lay down two way pallet.

Shatter Resistant Acrylic Windows

12"H x 32"W / 32"H x 12"W
4 vertical and 3 horizontal hinged windows (varies depending on blind model)
Tint option available.
Bottom edge of horizontal window at 38"
Bottom edge of vertical window at 32"

Maintenance-Free Exterior/Interior

All aluminum walls, floor and roof.

Wind Rated

80 MPH, F0 Tornado.

Weathertight

Bulb seals on every seam.

BLIND PURSUIT

IN HOUSE PRODUCTION

Start to finish built with pride in Iron Mountain, MI USA. Using the best materials from around the world.



SOLID STRUCTURAL SEAL AND RIGIDITY

Bolt through clear swing hinges create a tight seal between panels making the panel connections ready for years of use.



EASY GRIP HANDLE

Contoured L-shaped locking handle makes it easy to open and close the blind door.



SOUND SHIELD 360 CONCEAL MOVEMENT + NOISES

Sound-deadening blackout carpet on walls and floor keeps movement and noises concealed.

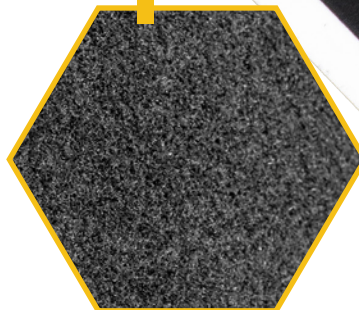

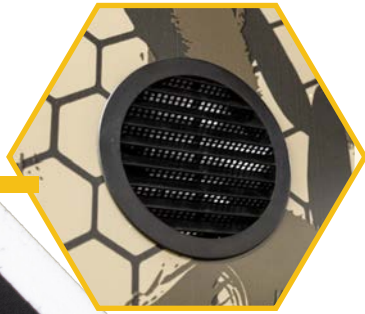

ELEMENTSHIELD360 WITH DUAL DOOR VENTILATION

All aluminum, critter proof exterior protects from the elements – top, bottom, and all sides – while the multiple vents allow moisture to escape while heating.

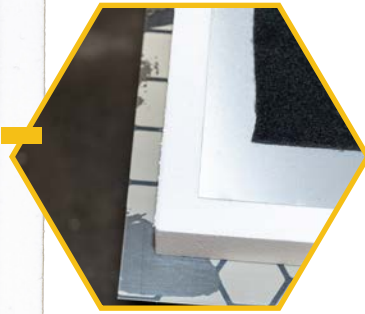

HUNTSHIELD360 CONCEAL SCENTS + STAY WARM

Layers to keep scent and warmth in – each panel has an aluminum exterior, 2” foam insulation, another layer of aluminum covered in carpet and held together with structural adhesive.



WEATHERPROOF WINDOWS

1” bulb seal keeps mother nature out and doubles as a cushioned shooting rest.



PATENTED QUICK LATCH SYSTEM

More than a 1400 lbs of latching pressure locks it together.

PUB. NO.: US 2022/0142146 A1

BLIND PURSUIT

HUNT WITHOUT LIMITS

Orion's modular, lightweight, all aluminum design allows you to set up camp anywhere you want to hunt - no heavy equipment, no problem

ORION 68 6' X 6' 8 SIDED



BLIND DIMENSIONS

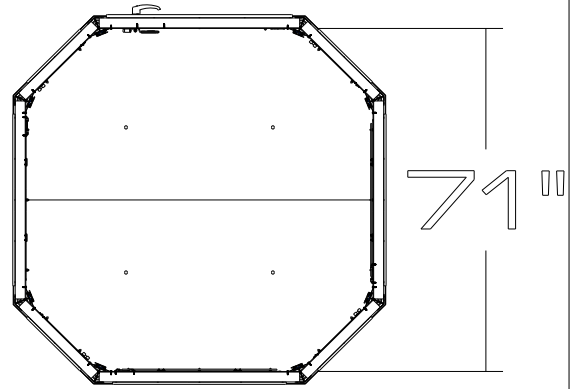

SPECS

- 6' diameter, eight sided blind.
- Panels can be quickly re-positioned for versatility depending on season.
- Vertical window can be added to the door.
- Clear or tinted windows.
- Locking door panel.

- 68V:** 6 vertical windows, 2 horizontal windows.
- 68 Combo:** 4 vertical windows, 3 horizontal windows.

82"



2 - 3 PERSON

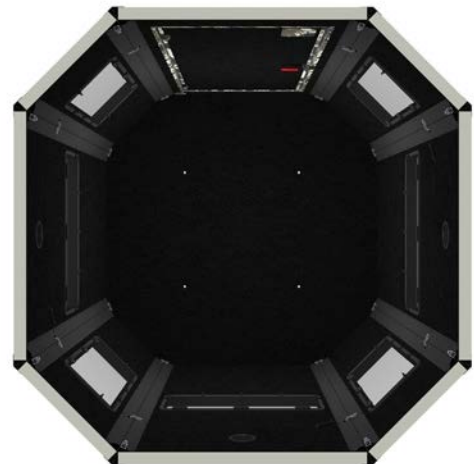



SEE THE VIDEO!

MODULAR
15 MINUTE
SETUP
PATENTED

ORION 55
5' X 5' 5 SIDED

\$



BLIND DIMENSIONS

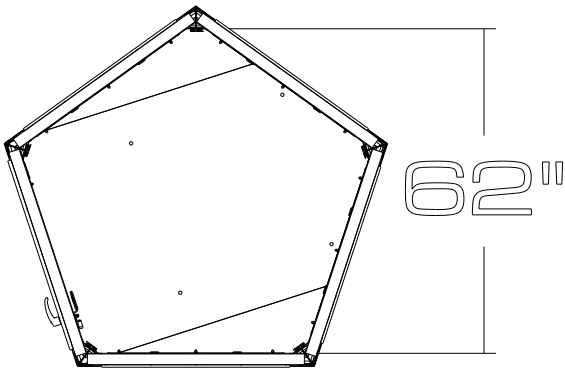

1 - 2 PERSON



SPECS

- 5' diameter, five sided blind.
- Clear or tinted windows.
- Locking door panel.

55: 4 horizontal windows.

55V: 4 vertical windows, 2 horizontal windows.

WHY ORION IS BETTER.

ENGINEERED FOR SAFETY AND STABILITY

Durable Powder Coat Paint

All steel design is critter proof and rust resistant.

Safety Inspired

Stairs and deck rail designed with commercial safety in mind. Slip resistant ladder, stair treads and deck.

Heavy-Duty Cross-Brace Structural Design

5' - 10' - 15' - a solid elevated tower.

Packaged Flat

Fits in the bed of standard size pickup trucks.

Simplified Assembly

Locking flange nuts eliminate the need for multiple washers.

Strength Through Engineering

Engineered to be stronger and lighter weight than competitors.

**MADE WITH
U.S. STEEL**



ELEVATE YOUR PURSUIT

SAFELY ENTER AND EXIT

A standard 40"W x 60"L deck won't have you leaning, twisting, and turning when entering the blind. Able to stand on deck to open door.

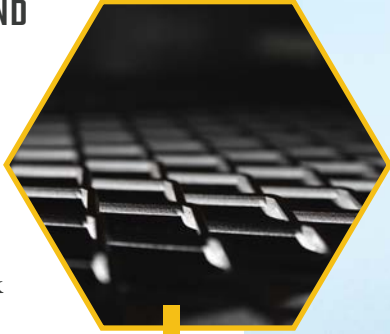

THREE POSITION STAIR

Unique to the industry. Position your entry based on your surroundings. Tight spots don't stand a chance.

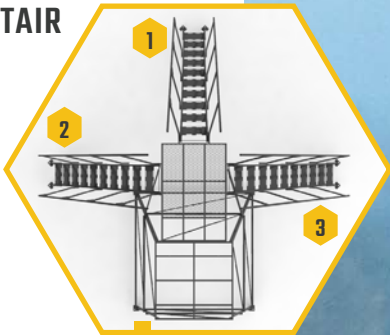

SLIP RESISTANT TREADS

Safely climb your ladder or stairs no matter the weather.





LOCK DOWN SAFETY ANCHORING SYSTEM

Seven-point anchoring system keeps your stand upright and locked down – for your safety and the safety of the product - even when not in use.



ROCK SOLID

Corner-to-corner angle braces on all sides gives this stand a superior structural design.



UNEVEN GROUND? LEVEL UP

Built-in leveling systems level up the stairs and the base, so your stand is level, even when the ground is not.



12” adjustability per leg.

ELEVATE YOUR PURSUIT

SHAKE TEST APPROVED, CRITTER PROOF, AND ROT RESISTANT

All steel and powder-coated elevated hunting stands that only require two tools for assembly - 9/16" wrench and a power impact drill.

SCAN ME
TO VIEW
ONLINE



1' LEVELING KIT

APPROXIMATE ASSEMBLY TIME: 10 MINUTES

\$

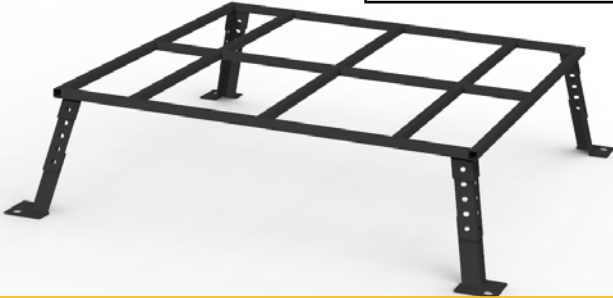

ADA RAMP KIT

APPROXIMATE ASSEMBLY TIME: 30 MINUTES



5' STAND WITH STAIR

APPROXIMATE ASSEMBLY TIME: 1 HOUR

\$

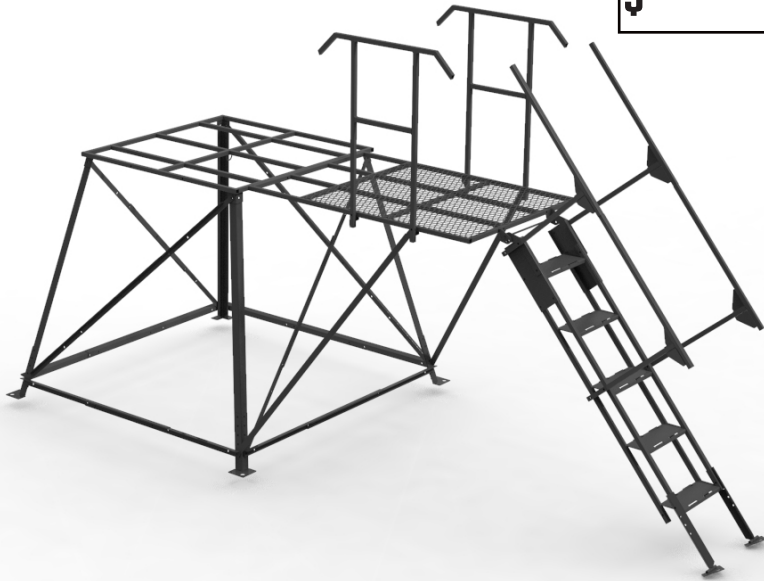

STAIR DIMENSIONS

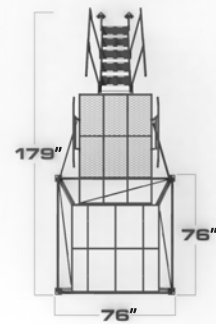

5' STAND WITH LADDER

\$



LADDER DIMENSIONS

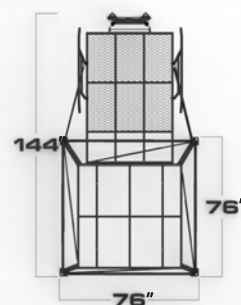

10' STAND WITH STAIR

APPROXIMATE ASSEMBLY: 2 HOURS

\$

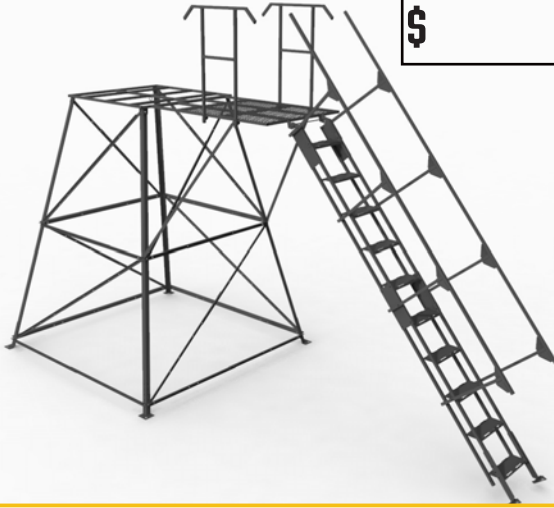

STAIR DIMENSIONS

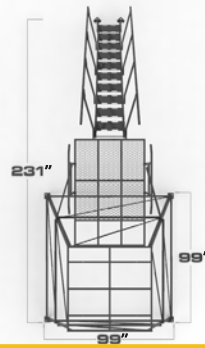

10' STAND WITH LADDER

\$



LADDER DIMENSIONS

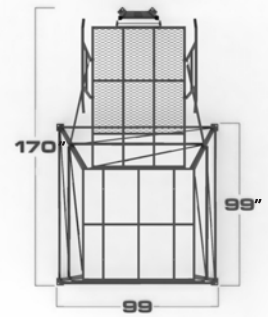

15' STAND WITH STAIR

APPROXIMATE ASSEMBLY: 3 HOURS

\$

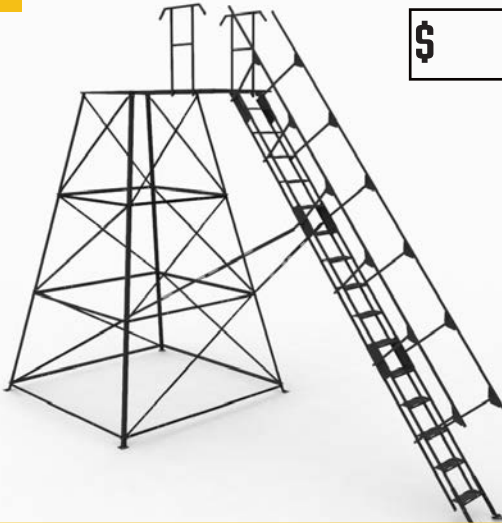

STAIR DIMENSIONS

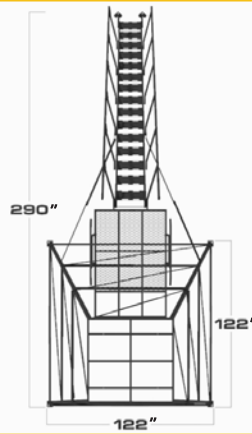

15' STAND WITH LADDER

\$

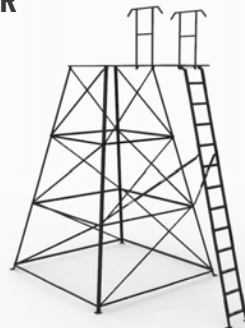

LADDER DIMENSIONS

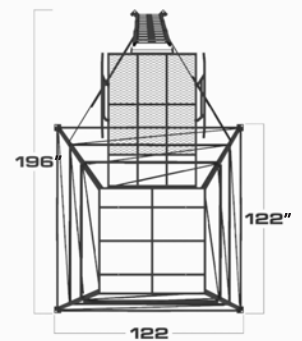

SET UP FOR SUCCESS.

**“ORION’S QUALITY,
FEATURES AND
DESIGN IS TRULY A
GAME CHANGER.”**

JOEL TAYLOR
WISCONSIN

**“BEST ELEVATED
BLIND, HANDS DOWN.
THEY KNOW WHAT
HUNTERS NEED.”**

RODNEY GERTH
MICHIGAN

**“GREAT INGENUITY,
ESPECIALLY WITH THE
MODULARITY OF THE
DESIGN.”**

SCOTT PURGERSON
TEXAS



**FIND YOUR
AUTHORIZED
DEALER HERE**



ACCESSORIZE YOUR HUNT

MAGNETIC BLACK WINDOW MESH (VERTICAL OR HORIZONTAL MAGNETIC)

Weatherproof, lightweight black window mesh allows you to see out but your game can't see in! Has six zinc plated grommets that attach to magnets on the window.

- Quantity of 4
- Mix and match vertical and horizontal
- Easy to install
- Quick full or partial removal



\$

PADED ACCESSORY SHELF WITH STORAGE

Keep your gear within arms reach and organized. Easily installs with included phillips head screws.

- Powder coated steel
- Cup holder
- Multiple hooks
- Gun barrel rest



\$



MODULAR STAND AND FILL FEEDERS

150lb - 1,050lb stand and fill, all steel. Bear, hog, varmint, and squirrel proof feeder. 12v solar broadcast spinner for corn and pellets.



\$



SCAN ME TO VIEW ACCESSORIES ONLINE

CUSTOM OPTIONS

- TINTED WINDOWS
- VERTICAL WINDOWS
- CUSTOM WINDOW CONFIGURATIONS
- CALL SALES FOR MORE DETAILS



\$



BOW/GEAR HOOK

Rubber edged heavy duty metal hook. Perfect to hang your bow or gear. Mounts anywhere with approved screws. 50 lb. capacity. Quantity of 3.

\$



HEIGHT ADJUSTABLE SWIVEL PEDESTAL CHAIR

Made of blackout waterproof, weather-resistant seat with Flex-Tek fabric for all day comfort stretched over a painted steel frame with padded armrests.

Adjustable footrest
360° of silent swiveling
Height adjustment from 17" - 24"
300 lb rating

\$



FLOOR MAT

Custom fit all-weather floor mat for your Orion Blind.



150LB

\$



450LB

\$



750LB

\$



1050LB

\$



What do you get when you take a group of engineers with a passion for hunting?

ORION HUNTING PRODUCTS FORGED IN THE NORTHWOODS

Growing up in the upper Midwest, hunting is a rite of passage. For generations, fathers and grandfathers teach their children the ways of the hunt - and ours were no exception.

As engineers, we wanted to improve on the traditional hunting blind and hunting stands available on the market. As hunters, we wanted to improve on the safety and comfort of hunting in rugged terrain and a variety of temperatures ranges. The safety measures incorporated into our Orion blinds and stands allow hunters of all ages to get out and hunt safely.

All Orion hunting blinds and Orion hunting stands are designed by engineers and fully manufactured at our facility in Iron Mountain, Michigan. Proudly made in the USA.



WWW.HUNTORION.COM

ORION HUNTING PRODUCTS - HUNT WITHOUT LIMITS. HUNT ORION.

15 YEAR WARRANTY

SCAN ME TO
FIND YOUR
NEAREST
AUTHORIZED
DEALER

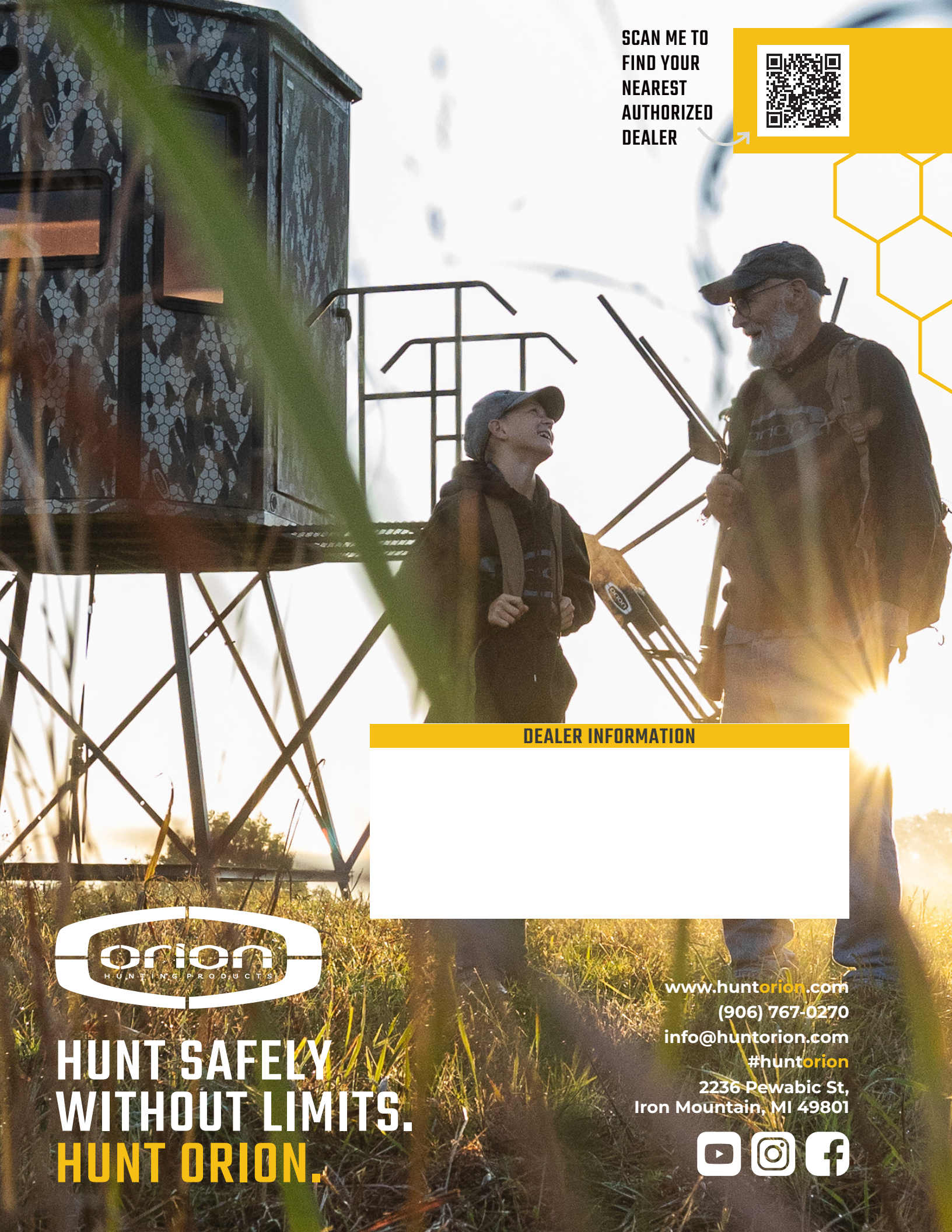

DEALER INFORMATION

Blank white area for dealer information.



**HUNT SAFELY
WITHOUT LIMITS.
HUNT ORION.**

www.huntorion.com

(906) 767-0270

info@huntorion.com

#huntorion

2236 Pewabic St,
Iron Mountain, MI 49801

